

## Stop valve NW 10 to 80 for water and oil max. 320 bar for block mounting and pipe mounting



### TECHNICAL DATA



Series AV 10-80 stop valves are operated by a handwheel. They were specially developed for water hydraulics. The stop valves can shut off the fluid flow from B to A or even from A to B. The stop valves are sealed by pressing two metal cones against one another. The max. working pressure must not exceed 320 bar.

#### Special features

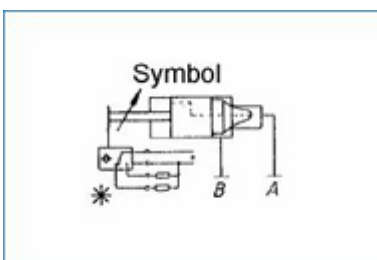
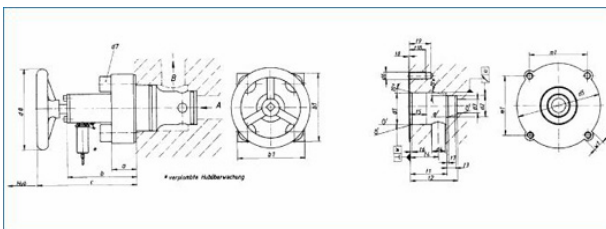
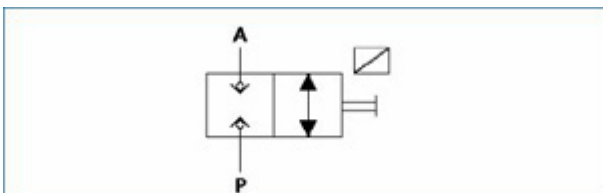
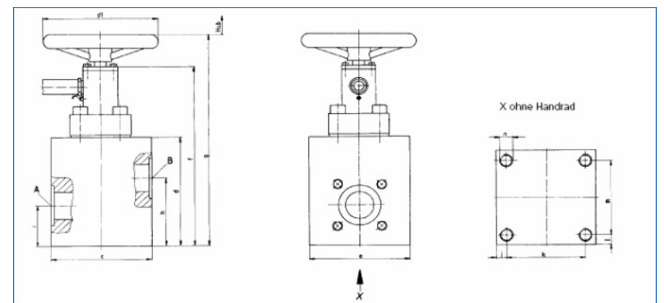
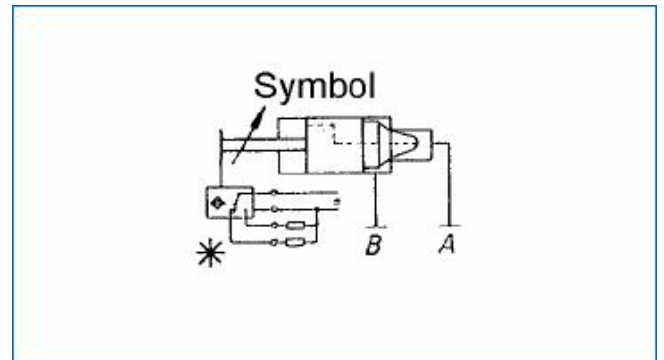
The stop valves can be operated under pressure. Stop valves of this type are almost insensitive with regard to the high flow speeds occurring in hydraulic press water systems. All wear parts are made of corrosion resistant materials, are easy to access and fast to replace. The mounting position can be freely chosen.



NG	16	25	32	40	65	80
A	∅16	∅25	∅32	∅40	∅65	∅80
B	∅16	∅25	∅32	∅40	∅65	∅80
c	110	140	150	160	260	280
d	110	145	170	200	300	370
e	110	140	150	160	260	280
f	219	250	341	355	532	620
g	270	297	360	412	589	720
h	75,5	101	118	136	205	240
i	35	45	55	60	90	100
j	15	20	25	20	30	30
k	80	100	100	120	200	220
l	15	20	25	20	30	30
m	80	100	100	120	200	220
n	M10	M10	M10	M12	M20	M20
D1	∅125	∅160	∅200	∅250	∅450	∅560
Hub	10	18	25	28	30	30

NG	AVIT-flange connection	
	A	B
10		
16	FA 16	FA 16
25	FA 25	FA 25
32	FA 32	FA 32
40	FA 40	FA 40
65	FA 65	FA 65
80	FA 80 	FA 80 

DN	16	25	32	40	50	63
a	25	35	40	50	55	55
a) b	109	106	132	146	185	232
a) c	160	158	190	214	275	315
a) Hub	10	13	17	22	28	30
b1	65	85	100	125	140	180
d1 <sup>H7</sup>	32	45	60	75	90	120
d2 <sup>H7</sup>	25	34	45	55	60	90
d3	16	25	32	40	50	63
d4	16	25	32	40	50	63
d5	66	86	103	126	141	181
d6	M8	M12	M16	M20	M20	M30
d7	M8x50	M12x50	M16x60	M20x80	M20x80	M30x100
d8	∅25	∅160	∅200	∅250	∅360	∅500
m1	46	58	70	85	100	125
t1*8 <sup>1</sup>	43	58	70	87	100	130
t2*8 <sup>1</sup>	56	72	85	105	122	155
t3	11	12	13	15	17	20
t4	34	44	52	64	72	95
t5	20	30	30	30	35	40
t6	2	2,5	2,5	3	4	4
t7	2	2,5	2,5	3	4	4
t8*0,5	0,5	0,5	0,5	0,5	0,5	0,5
t9	21	26	32	45	45	75
t10	15	20	22	35	35	65
u	0,03	0,03	0,03	0,05	0,05	0,05
w	0,05	0,05	0,1	0,1	0,1	0,2
w1	∅10	∅14	∅18	∅22	∅22	∅32